

LKF-Industrial

Coalescence filter

Translation of the original instructions



Legal notice

Willibrord Lösing Filterproduktion GmbH
Am Walzwerk 2
45527 Hattingen
Germany

Telephone	+49 2324 9460-0
Fax	+49 2324 40842
e-mail	info@loesing-filter.de
Internet	www.separ.de
Owner	Ingeborg Lösing
Procurators	Boris Lösing Marcus Hahne Thomas Held
Commercial Register	Essen District Court
Registration number	HRB 15543

Table of contents

Legal notice	II
Table of contents	III
Table of tables	V
Table of figures	VII
Information about this instruction	1
Storage	1
Replacement	1
Copyright	1
Handling instructions	1
Notes	1
Notes on safety	2
Notes	2
Embedded notes	3
Safety information	4
Intended use	4
Installed situation	4
Fuel specification and temperature ranges	4
Predictable misuse	4
Improper handling	5
Basic notes on safety	8
Technical data	9
Scope of delivery	9
Mechanical data	9
Performance data	10
Identification	10
Structure	11
Mechanical connections	12
Function	12
Storage	12
Transport	12
Installation	13
Safety information	13
Mounting material	13
Tools	14
Mounting	14
Connection	15
Connection example 1: Inlet left side and outlet right side	17
Connection example 2: Inlet right side and outlet left side	17
Connection example 3: Inlet and outlet on one side	18
Initial commissioning	19
Disassemble container	19
Mount water sensor	20
Position container	20
Assemble container	21
Fill filter	22
Maintenance	23
Safety information	23
Visual inspection	24
Assemble disassembled filter	25
Complete drain valve	25

Complete container.	26
Complete filter element	26
Insert filter element into the container	26
Assemble container	27
Drain filter	28
Discharge filter	29
Change filter element	29
Clean container	31
Waste disposal	31
Spare parts	32
Accessories	33



Table of tables

Explanation of the symbols on the rating plate	10
Spare parts	32
Accessories	33

Table of figures

LKF wrench, structure	7
Dimensions	9
Rating plate	10
Structure	11
Mechanical connections	12
Mounting dimensions	14
Connection dimensions	15
Mechanical connections	16
Connection example: Inlet left side and outlet right side	17
Connection example: Inlet right side and outlet left side	17
Connection example: Inlet and outlet on one side	18
Disassemble container	19
Tapped hole for the water sensor	20
The four positions of the container	20
Assemble container	21
Hand fuel pump SEPAR HFP	22
Individual parts of the filter	25
Admissible maximum water level	28

1 Information about this instruction

This instruction includes information related to the life cycle of the product. It is directed toward specialist personnel who handle, install and maintain the product.

A specimen in the original language is enclosed with every translation of this instruction. Should uncertainties or discrepancies be determined in the translation, before the utilisation of the supplied product the instruction in the original language must be referred to for clarification and the manufacturer informed.

It is possible that illustrations in this instruction are used as an example and therefore do not agree exactly with the product supplied.

1.1 Storage

This instruction is a component part of the product. It should be stored near the product and protected against environmental impacts.

1.2 Replacement

If this instruction should become illegible or be lost, a replacement document can be acquired from the manufacturer. For this purpose, the reference number of the instruction must be known, which can be found in the footer on the inside margin of every page.

1.3 Copyright

Willibrord Lösing Filterproduktion GmbH has copyright to all documents with the Willibrord Lösing Filterproduktion GmbH company signature. Without approval of the Willibrord Lösing Filterproduktion GmbH, such documents may not be either made accessible to third parties or used in any other manner or improperly.

It is admissible, within a documentation management system, to make it available as an electronic document or a hardcopy for in-house use.

1.4 Handling instructions

Work and procedures are described by handling instructions:

- ▶ This is a prerequisite which must be met.
- ▶ A further prerequisite which must be met.
 1. This handling step is implemented first.
 - That is the result of the handling step.
 2. That is a further handling step.
- = That is the result of the handling instruction.

1.5 Notes

Notes draw attention to situations which can lead to object damage or injuries to persons if certain rules of conduct are not adhered to.

1.5.1 Notes on safety

Notes on safety draw attention to dangers to health. The general safety symbol in the following examples can be replaced in concrete notes on safety by a hazard-specific symbol.

DANGER



Type and source of risk

Failure to observe the rule of conduct may result in most serious injuries or death!

Rule of conduct.

WARNING



Type and source of risk

Failure to observe the rule of conduct may result in serious physical injuries!

Rule of conduct.

CAUTION



Type and source of risk

Failure to observe the rule of conduct may result in physical injuries!

Rule of conduct.

1.5.2 Notes

Notes draw attention to the correct handling of the product in order to avoid material damage.

NOTICE



Type and source of risk

Failure to observe the rule of conduct may result in property damage!

Rule of conduct.

1.5.3 Embedded notes

If dangerous situations can occur during work or if inappropriate behaviour is possible, attention is drawn to this by embedded notes in handling instructions:

1. Handling step

**DANGER****Type and source of risk! Rule of conduct.**

2. Handling step

**WARNING****Type and source of risk! Rule of conduct.**

3. Handling step

**CAUTION****Type and source of risk! Rule of conduct.**

4. Handling step

NOTICE**Type and source of risk! Rule of conduct.**

2 Safety information

The safety information is to be considered in performing all work.

2.1 Intended use

The filter is suitable for the cleaning and water-removal of light diesel oils, in accordance with DIN EN 590. It is installed in the supply flow pipe of the fuel circuit.

2.1.1 Installed situation

If the supply flow of the filter is below the maximum filling level in the tank, a blocking valve must be installed between tank and filter.

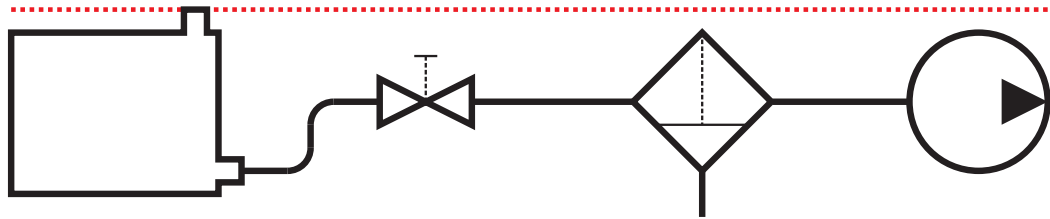

If the supply flow of the filter is above the maximum filling level in the tank, a blocking valve between tank and filter is not required as mandatory.

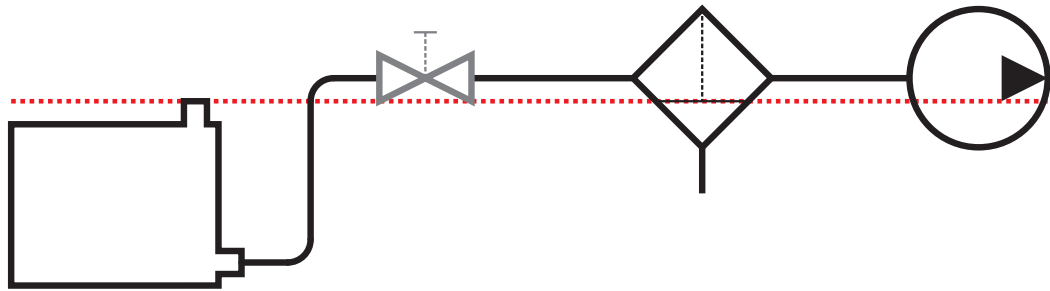

Basically we recommend to install a blocking valve.

2.1.2 Fuel specification and temperature ranges

DIN EN 590	-20 °C to 80 °C
DIN V 51603- 6	-20 °C to 80 °C
DIN EN 16709:2019 (B20 and B30).....	-20 °C to 80 °C

The possible use with fuels not specified here or in other temperature ranges can be inquired if required.

2.1.3 Predictable misuse

The maximum flow rate of the filter must be greater than or equal to the maximum pump capacity of the fuel pump.

For the supply pipe to the filter, the following component parts may be used exclusively:

- Straight pipe pieces.
- Pipe bends with a radius which corresponds to at least three times the outer diameter of the pipe.
- Connectors and blocking elements which do not restrict the free cross-section of the pipe.

2.1.4 Improper handling

The container is secured by a ring with bayonet lock. The two interlocks are located diametrically on the mounting side and the front side of the filter.

Improper handling of the interlock can lead to damage to the filter and as a consequence cause malfunctions and environmental damage. The bayonet lock may only be opened and closed by hand or with the LKF wrench, which is available as an accessory.

The following descriptions explain the basically correct procedure. When working on the filter, the safety instructions in the respective chapters must also be observed.

2.1.4.1 Correct opening of the bayonet lock

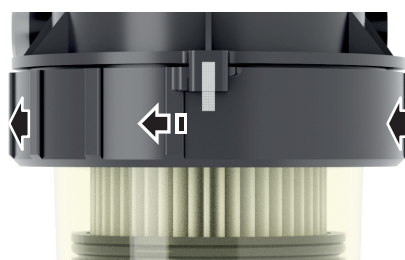

The figure shows the front view of the filter. Grasp the bayonet ring on both sides and turn counter-clockwise beyond the resistance.



Turn the bayonet ring further counter-clockwise, it will lower itself.



The figure shows the view of the filter from the left side. Turn the bayonet ring further counterclockwise until it can be removed downwards.

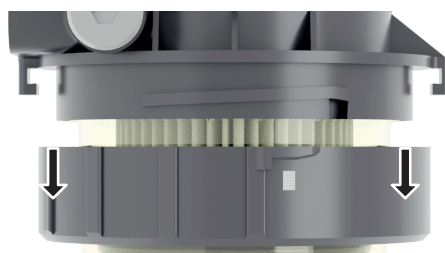

The bayonet ring can now be removed downwards from the filter.

2.1.4.2 Correct closing of the bayonet lock



The figure shows the view of the filter from the left side.

Slide the ring over the container from below. Turn the ring so that the guide nose is approximately in the middle of the filter.

Push the ring on completely and without tilting until it resists.

Maintain pressure and turn the ring clockwise until resistance is reached.

The figure shows the front view of the filter. Turn the ring clockwise beyond the resistance.

Turn the ring further clockwise until it stops.

The filter is only correctly closed if the markings on the lock are aligned.

2.1.4.3 Use of the LKF wrench



Abbildung 1: LKF wrench, structure

1	Handle	3	Guide pin
2	Pivot pin		



The bayonet ring of the filter is divided into 12 sections at its bottom. The LKF wrench can be inserted there in steps of approx. 30° around the centre axis of the bayonet ring.

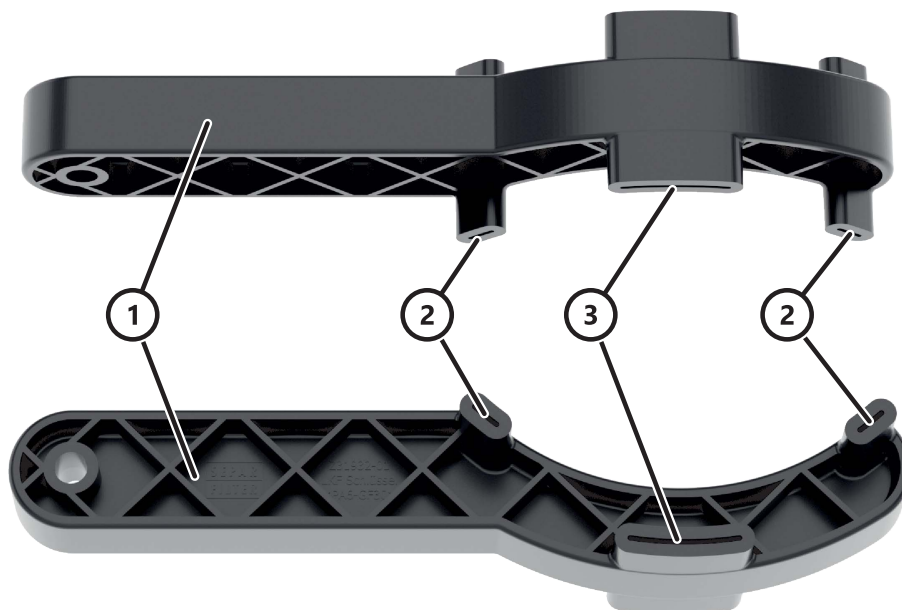

Position the wrench so that the bayonet ring can be turned in the correct direction. The wrench can be used in any position to open or close the bayonet ring.



Turn the wrench so that the two pivot pins can be inserted from below into two of the sections in the bayonet ring. The guide pin must be on the outside of the bayonet ring.



Insert the wrench into the bayonet ring as far as the stop. Make sure that the wrench is not tilted in its longitudinal and transverse axis when turning the bayonet ring and that the pivot pins remain completely in the bayonet ring.

2.2 Basic notes on safety

CAUTION



Skin and eye irritation!

In case of contact with diesel oil, skin and eyes can become irritated!

When working with fuels, the following must always be observed:

1. When indicated, wear protection gloves that protect against diesel oil.
2. When indicated, wear eye protection.
3. In case of skin contact, wash off the affected areas of the skin thoroughly and apply skin protection ointment.
4. In case of eye contact, flush the eye immediately with flowing water and then consult a doctor.

CAUTION



Environmental damage!

Fuel discharging into the environment can cause damage!

When working with fuels, the following must always be observed:

1. Protect the work area so that any leaking fuel is safely collected.
2. Prior to commencement of work, exclude any leakage of fuel by suitable measures.
3. Collect any residue of leaked fuel completely with suitable materials on completion of the work.
4. Implement non-polluting waste disposal of any collected fuel, as well as materials impregnated with fuel.

3 Technical data

The manufacturer reserves the right to change the technical characteristics as a result of product improvements without special announcement.

3.1 Scope of delivery

Filter, optionally with

- 4 M16×1,5 sealing plugs and 1 PG7 sealing plug
- 4 M16×1,5 sealing plugs and water sensor

3.2 Mechanical data



Abbildung 2: Dimensions

Material.	plastic, material proportions on request
Mass	approx. 800 g
Ambient temperature range.....	-40 °C to 85 °C
Media connectors	
Screw tap	M16×1.5 / ISO 9974- 1
Screw-in-capable length of thread	≤17 mm
Tightening torque.....	15 Nm ±1 Nm
Water sensor connector	
Internal thread.....	PG7
Tightening torque.....	screw in manually until the limit stop is reached

3.3 Performance data

Performance data items are limit values. By the integration of the filter into an existing infrastructure, the indicated performance data can be limited under certain circumstances.

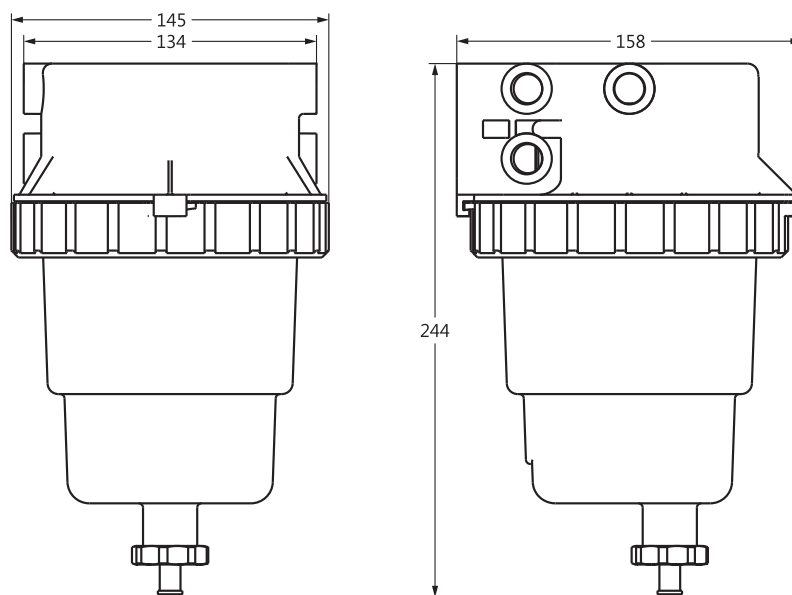
- Volume flow ≤8 l/min
- Operating pressure (with reference to ambient pressure)
 - Continuous pressure -0.8 bar to 1.5 bar
 - Maximum pressure..... 2 bar ≤15 s
- Inflow-outflow differential pressure ≤500 mbar



3.4 Identification



Abbildung 3: Rating plate

4	Type designation	7	QR code for the downloading of the instruction
5	Address of the manufacturer	8	Performance data
6	Serial number		

Tabelle 1: Explanation of the symbols on the rating plate

Symbol	Meaning
	Special waste, dispose of environmentally correctly
	Suitable only for diesel oil
	The device is equipped with a transponder which is activated with a radio frequency
Technical data	Technical data
Date of production	Date of manufacture
Serial no	Serial number
Filling volume	Filling volume of the filter
Flow rate	Volume flow
Temperature range	Ambient temperature range
Instructions	Note on the QR code for the downloading of the instructions

3.5 Structure



Abbildung 4: Structure

1	Filter body with media connectors	9	O-ring seal container/drain valve
2	O-ring seal filter element/filter body	10	Drain valve
3	Filter element	11	Sealing plug PG7 for screw-in thread water sensor
4	O-ring seal container/filter element	12	Sealing plug M16×1.5 for unused connectors
5	O-ring seal container/filter body	13	
6	Container	14	
7	Bayonet ring	15	
8	O-ring seal for drain valve seating		

3.6 Mechanical connections

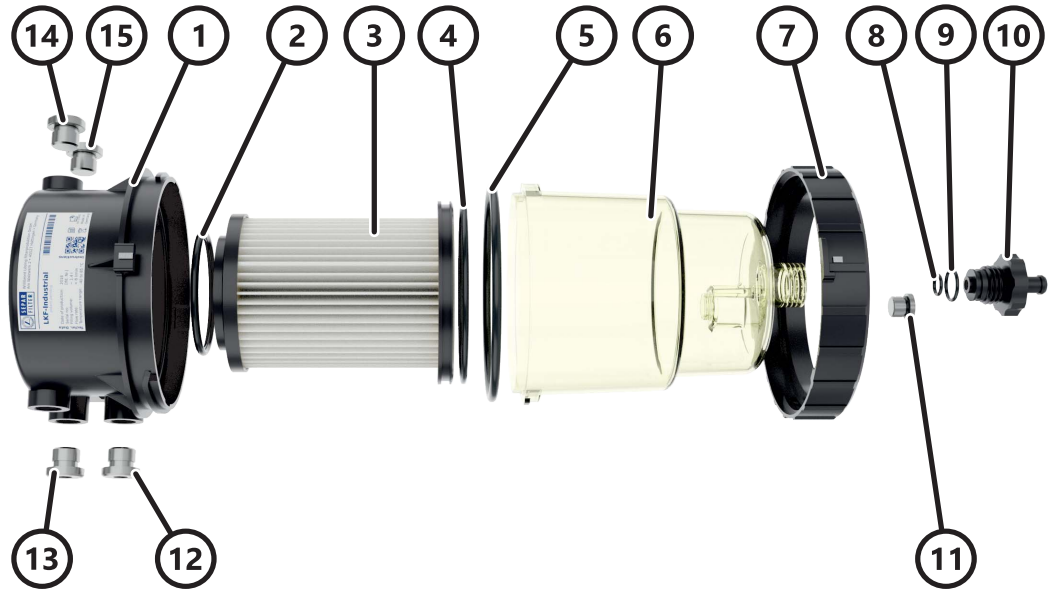

Abbildung 5: Mechanical connections

1	For future expansion	5	Nozzle for drain hose
2	Medium supply flow, right	6	Medium flow, left
3	Medium flow, right	7	Medium supply flow, left
4	Screw-in thread for water sensor	8	For future expansion

4 Function

The medium suctioned by the fuel pump flows into the filter. A patented, multi-stage process first mechanically retains particles and suspended matter. Subsequently, water contained in the medium is separated, which collects at the bottom of the container. After that the cleaned medium leaves the filter.

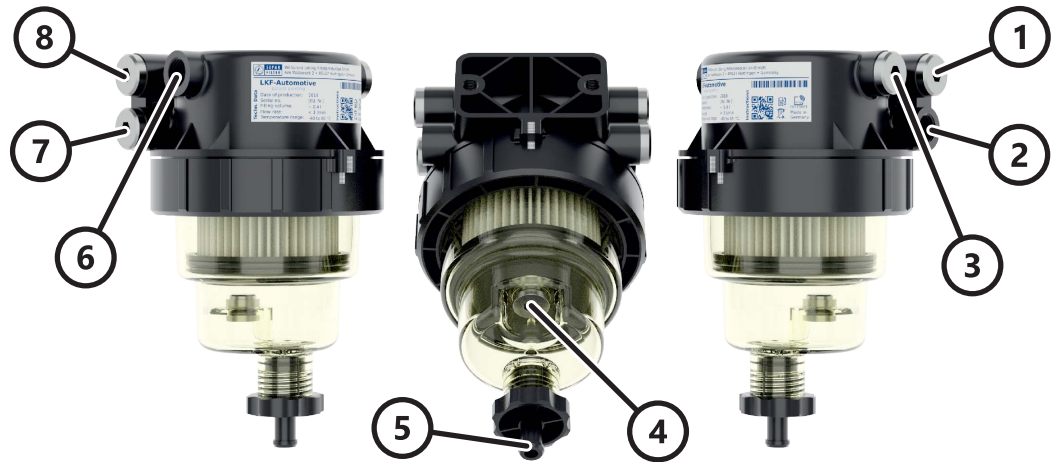
5 Storage

The filter can be stored in its original packing or alternatively wrapped dust-protected in air-cushion film.

Storage temperature range -40 °C to 85 °C

Air humidity level ≤80%, non-condensing

6 Transport

The filter can be transported in its original packing or alternatively wrapped dust-protected in air-cushion film.

When transporting, the filter may not

- be thrown about.
- be let fall.
- be impacted.
- be loaded with heavy objects.
- come in contact with sharp and/or pointed objects.

7 Installation

NOTICE

Transport damages!

A damaged filter can lead to consequential damage due to leaking medium!

Before installation

1. check the filter for visible damage.
2. check the package content for completeness.
3. when indicated, replace damaged parts and extend lost parts or use a new filter.

NOTICE

Dust caps!

For the protection of the filter, all mechanical connections are sealed ex works!

The dust caps may only be removed when installing the filter.

7.1 Safety information

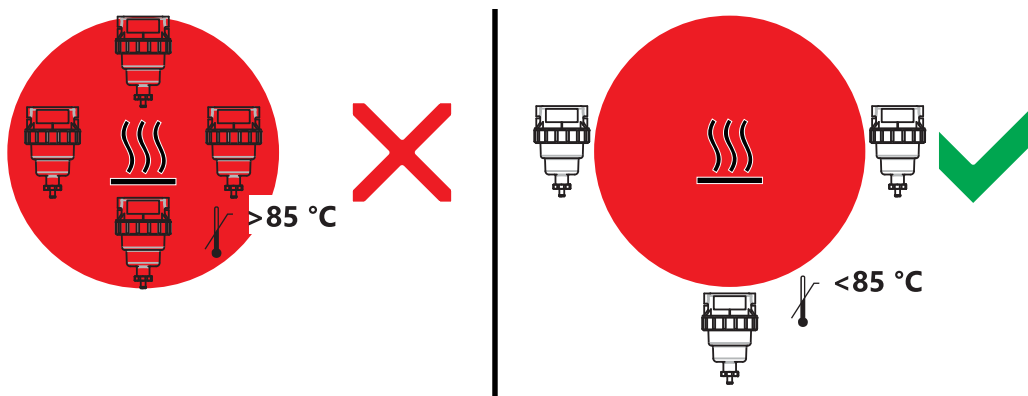

CAUTION



Consider ambient temperature!

Too high temperatures can damage the filter and lead to consequential damage due to leaking medium!

Install the filter so that

- the installation surface causes no inadmissible heating.
- the filter is not in the irradiation range of hot system parts.
- when indicated, a heat shield can be mounted for the protection of the filter.

7.2 Mounting material

2 machine screws

Thread size M8

Length of thread 12 mm to 24 mm

Tightening torque 5 Nm \pm 1 Nm

2 spring lock washers DIN 127

The length of the fastening screws must be selected so that the screw thread grips over the full length of the screw tap and does not protrude more than 12 mm in the tightened status.

7.3 Tools

Torque wrench AF13
 Drill machine
 Drill 8.5 mm or 9 mm

7.4 Mounting

The filter is fixed with two machine screws which are screwed into the mounting flange.



Abbildung 6: Mounting dimensions

- ▶ The filter is undamaged and the package content is complete.
 - ▶ A clearance height of at least 310 mm is existing at the mounting location.
 - ▶ The filter can be mounted so that sufficient space remains under the drain nozzle for the connection of the drain hose.
 - ▶ The mounting flange does not protrude over the mounting surface.
1. Drill two holes at correct separation distance from each other and horizontal to each other.
 2. Deburr bores.
 3. Insert both screws through from the rear side of the mounting surface and screw hand-tight into the mounting flange of the filter.
 4. Align filter so that its axis is vertical.
 5. Fix filter and tighten both screws with the admissible torque.
- = The filter is mounted.

7.5 Connection

The media connectors are designed as tapped holes according to ISO 9974-1. Sealing plugs or connectors, which correspond to ISO 9974-2, can be screwed into them.

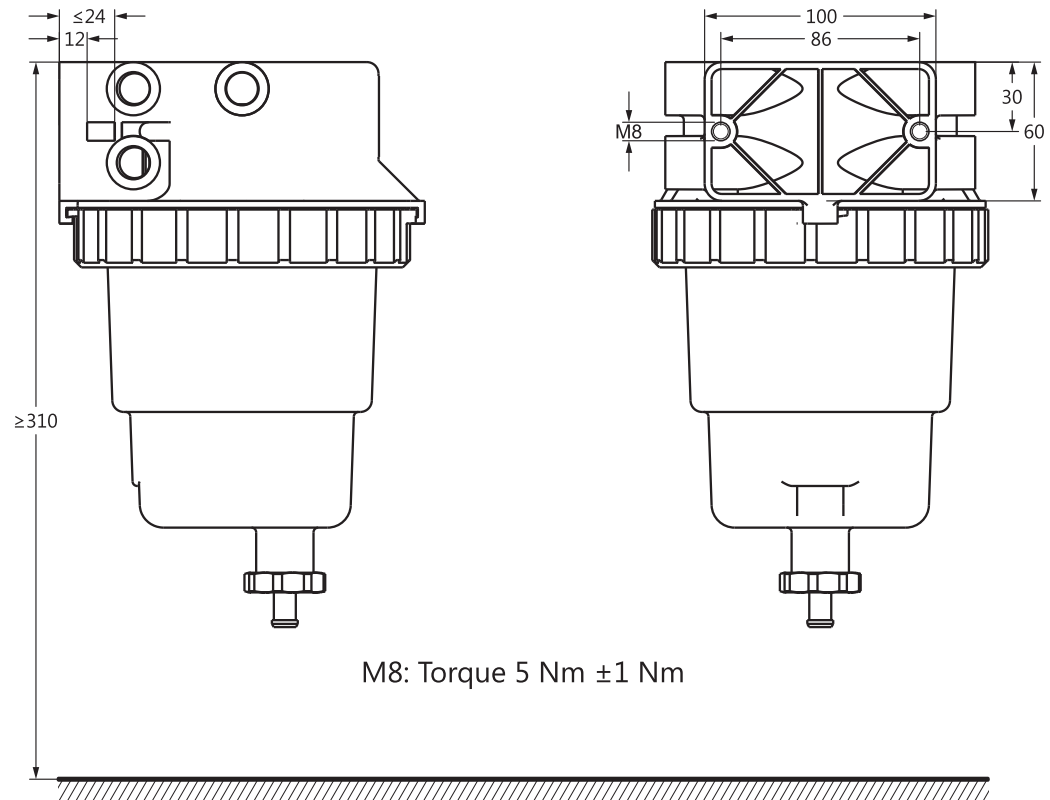

Abbildung 7: Connection dimensions



Abbildung 8: Mechanical connections

1	For future expansion	5	Nozzle for drain hose
2	Medium supply flow, right	6	Medium flow, left
3	Medium flow, right	7	Medium supply flow, left
4	Screw-in thread for water sensor	8	For future expansion

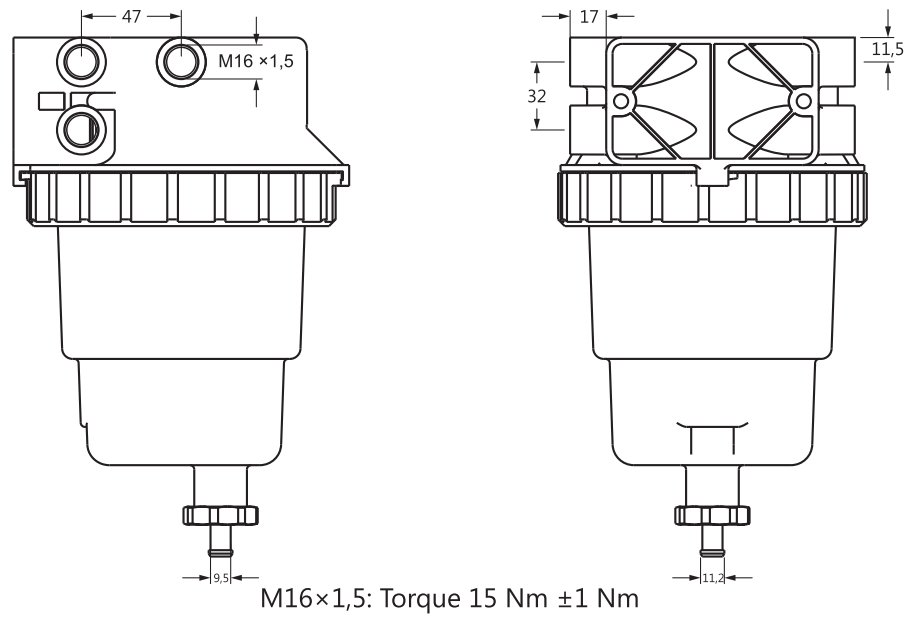
Medium supply flow

Connection for the fuel pipe from the deepest point of the tank.

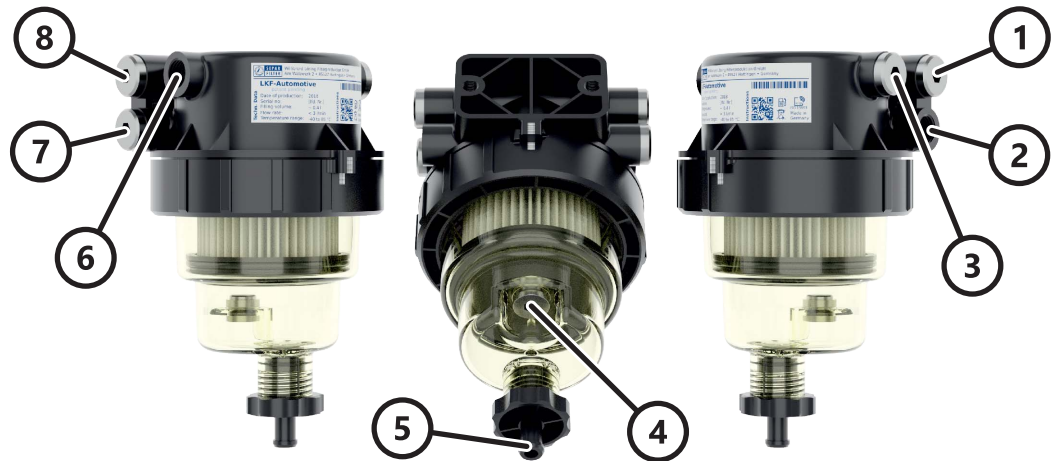
Medium flow

Connection for the fuel pipe to the injection system.

Medium return flow

Connection for the return flow pipe of the injection system. The already warmed-up fuel in the return flow is mixed with the fuel coming from the tank.

The return flow pipe to the tank is connected to the complementary connection on the opposite side of the filter. The filter is also vented over this.

Nozzle for drain hose

For simpler drainage of the filter, a hose which is suitable for the medium can be slid on.

Screw-in thread for water sensor

A water sensor which is available as an accessory can be screwed into this screw tap, where the sensor must be evaluated by additional electronics. Thus a signal can be generated indicating when the filter must be drained.

7.5.1 Connection example 1: Inlet left side and outlet right side



Abbildung 9: Connection example: Inlet left side and outlet right side

- ▶ The filter is mounted.
 1. Connect the line from the tank (IN) to the medium inlet on the left side of the filter.
 2. Connect the line from the filter to the injection system (OUT) to the medium outlet on the right side of the filter.
 3. Close all still open medium connections with one sealing plug each.
- = The filter is connected.

7.5.2 Connection example 2: Inlet right side and outlet left side



Abbildung 10: Connection example: Inlet right side and outlet left side

- ▶ The filter is mounted.
 1. Connect the line from the tank (IN) to the medium inlet on the right side of the filter.
 2. Connect the line from the filter to the injection system (OUT) to the medium outlet on the left side of the filter.
 3. Close all still open medium connections with one sealing plug each.
- = The filter is connected.

7.5.3 Connection example 3: Inlet and outlet on one side



Abbildung 11: Connection example: Inlet and outlet on one side

- ▶ The filter is mounted.
 1. Connect the line from the tank (IN) to the medium inlet on the left (right) side of the filter.
 2. Connect the line from the filter to the injection system (OUT) to the medium outlet on the left (right) side of the filter.
 3. Close all still open medium connections with one sealing plug each.
- = The filter is connected.

8 Initial commissioning

Before commissioning, possibly a water sensor must be mounted or the container must be rotated into another position.

8.1 Disassemble container



Abbildung 12: Disassemble container

- ▶ The filter is mounted.
- ▶ A water sensor should be assembled and/or the container should be rotated.
 1. Grip the bayonet ring with both hands and loosen counter-clockwise over the resistance.
 2. Secure the container against falling down and loosen the bayonet ring completely with a quarter turn counter-clockwise.
 3. Pull off the bayonet ring down over the container and place to the side.
 4. Pull the container down from the filter body.

NOTICE

Ensure with pulling off the container that the filter element is pulled out from the filter body as well.

- = The container is disassembled.

8.2 Mount water sensor



Abbildung 13: Tapped hole for the water sensor

1. Remove the sealing plug from the container and keep safe.
 2. Check the seal of the water sensor for correct position.
 3. Clean the sealing surface on the container with a soft cloth.
 4. Carefully screw the water sensor into the thread in the container by hand and tighten by hand until the stop is reached.
- = The water sensor is mounted.

8.3 Position container

For optimum access to the drain valve or water sensor, the container can be inserted into the filter housing in four positions.

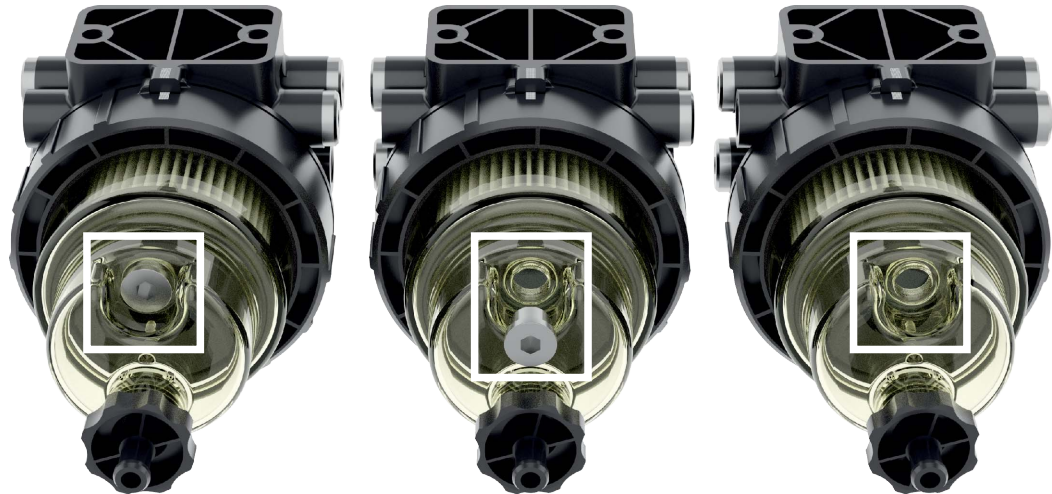
For this purpose, the container is mounted on the filter body rotated a quarter turn around the longitudinal axis in each case. The positioning is implemented over two pins arranged diametrically on the container, which are guided by two of the four slots in the filter body in each case.



Abbildung 14: The four positions of the container

8.4 Assemble container



Abbildung 15: Assemble container

- ▶ The filter element is inserted correctly into the container.
- ▶ The sealing surfaces on the container and in the filter body are cleaned.
 1. Rotate the container around its longitudinal axis in order to get it into the approximate assembly position.
 2. Slide the container into the filter body from below. Ensure in this case that the filter element slides into the filter body without canting.
 3. Align the pins on the container by rotating so that they grip into the slots in the filter body.
 4. Using light pressure, move the container into the filter body up to the stop and hold fixed.
 5. Slide the bayonet ring over the container and screw onto the screw thread on the filter body until resistance can be felt.
 6. Take the bayonet ring with both hands and rotate fixed clockwise until it engages in its end position.
- = The container is assembled.

8.5 Fill filter

A suitable pump must be connected to the connection for the medium outlet, with which fuel can be sucked from the tank. We recommend integrating the SEPAR HFP hand fuel pump, available as an accessory, into the fuel line after the filter.



Abbildung 16: Hand fuel pump SEPAR HFP

As soon as the filter is filled completely with fuel and vented, the operation can be started.

9 Maintenance

Regular inspection of the filter ensures its permanent function and protects the engine from damage.

NOTICE



Malfunction!

Maintenance work on a filter in the active fuel circuit can lead to malfunctions and, as a consequence, to environmental damage!

In case of maintenance work, the following must always be observed:

1. Before starting work, deactivate the fuel circuit.
2. If there is a pressure difference between the filter and the environment, equalize it before starting work.
3. Ensure correct position of all connections and seals.
4. Check the filter for leaks after recommissioning.

9.1 Safety information

CAUTION



Environmental damage!

Replaceable items contaminated with fuel or cleaning agents can cause environmental damage!

In case of maintenance work, the following must always be observed:

1. Prior to commencement of work, prevent any leakage of fuel from the tank by suitable measures.
2. Collect the fuel from the filter completely using a suitable vessel.
3. Place exchanged parts so that any possibly leaking fuel is securely absorbed.
4. Collect any residue of leaked fuel completely with suitable materials on completion of the work.
5. Ensure a non-polluting waste disposal of exchanged parts and the collected fuel, as well as materials used for cleaning.

9.2 Visual inspection

The time interval between visual inspections depends on the operation conditions. The following conditions shorten these intervals, in particular when they occur in combination:

- High ambient temperature
- Severe vibration and/or shaking
- Bad fuel quality

The following points are to be checked with a visual check:

1. Can any lack of sealing be determined?
→ When indicated, localise leaking point(s) and seal.
2. Can any damage be determined (cracks, breakouts)?
→ When indicated, replace damaged part.
3. Can dirt precipitation be determined in the container?
→ When indicated, *Clean container* (→ 31).
4. Check the water level in the container in case of filter without water sensor.
→ When indicated, *Drain filter* (→ 28).
5. In case of filter without differential pressure measurement, check the filter element for cleanliness.
→ When indicated, *Change filter element* (→ 29).

9.3 Assemble disassembled filter

A filter without accessories consists of the following individual parts:



Abbildung 17: Individual parts of the filter

1	Filter body with media connectors	9	O-ring seal container/drain valve
2	O-ring seal filter element/filter body	10	Drain valve
3	Filter element	11	Sealing plug PG7 for screw-in thread water sensor
4	O-ring seal container/filter element	12	Sealing plug M16×1,5
5	O-ring seal container/filter body	13	Sealing plug M16×1,5
6	Container	14	Sealing plug M16×1,5
7	Bayonet ring	15	Sealing plug M16×1,5
8	O-ring seal for drain valve seating		

9.3.1 Complete drain valve

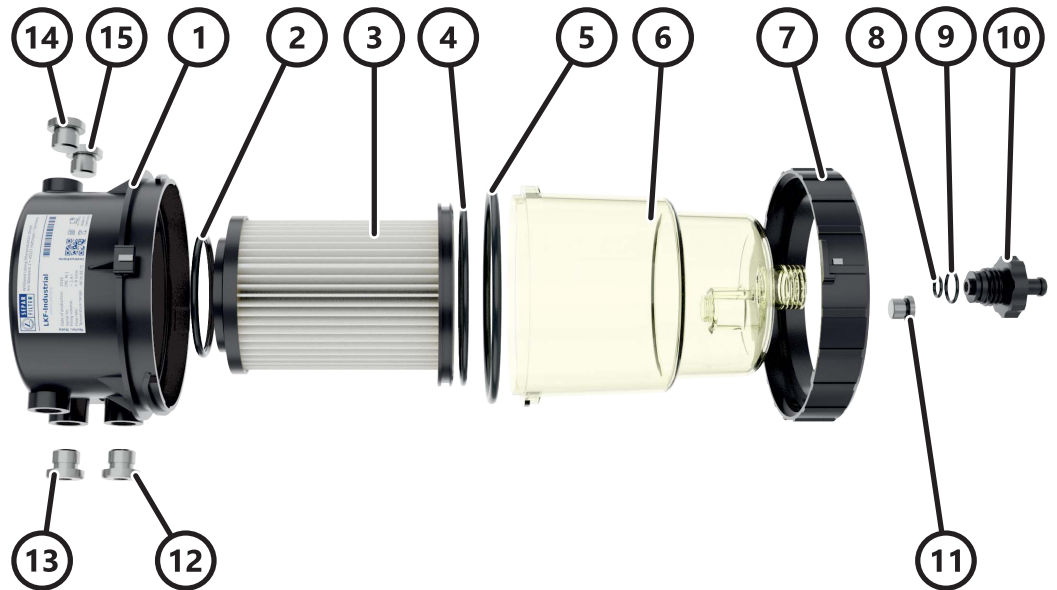

9.3.2 Complete container.



9.3.3 Complete filter element



9.3.4 Insert filter element into the container



9.3.5 Assemble container



9.4 Drain filter

A filter must be drained immediately when

- it is equipped with a water sensor and the maximum water level is signalled.
- With the visual check, a water level which was too high was determined.









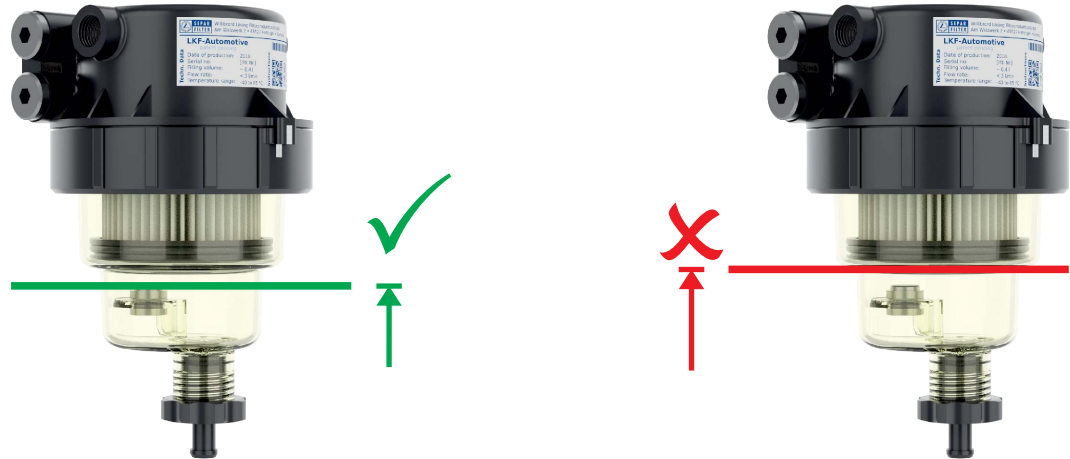
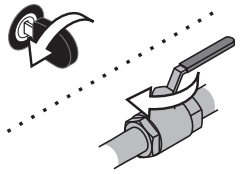

Abbildung 18: Admissible maximum water level

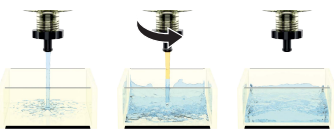
 <p>1 Stop machine or block supply pipe.</p>	 <p>2 Release the drain valve and open it about half a turn.</p>	 <p>3 Loosen one sealing plug or one pipe connection and open it by about one turn.</p>
 <p>4 Open the drain valve. Drain off water. Close the drain valve at the latest when diesel oil leaks.</p>	 <p>5 Tighten the loosened plug or the loosened pipe connection with the specified torque.</p>	 <p>6 Start machine or unblock supply pipe.</p>

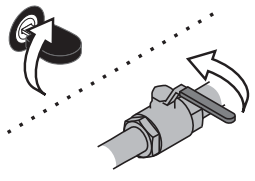
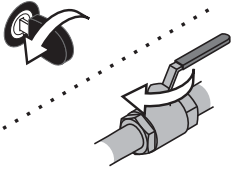
9.5 Discharge filter

For work on the filter it must be completely drained.











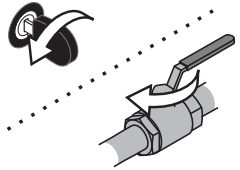

 <p>1 Stop machine or block supply pipe.</p>	 <p>2 Release the drain valve and open it about half a turn.</p>	 <p>3 Loosen one sealing plug or one pipe connection and open it by about one turn.</p>
 <p>4 Open the drain valve. Drain filter contents. Close drain valve.</p>	 <p>5 Tighten the loosened plug or the loosened pipe connection with the specified torque.</p>	

9.6 Change filter element

The filter element must be changed regularly, at the latest, 12 months after operational start-up.

Whether an earlier change is required can be determined unambiguously only with a differential pressure measurement between medium supply flow and medium run-off. If such measuring equipment is not available, the condition of the filter element must be tested regularly by a visual check. We recommend to change the filter element in case of soiling which is obviously identifiable from externally and to also clean the container in this case.

With the change of the filter element, basically new seals must be used and the sealing surfaces in the filter body, as well as in the container, cleaned free of residue. An already used filter element may not be used again.

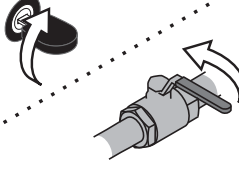
 <p>1 Stop machine or block supply pipe.</p>	 <p>2 Release the drain valve and open it about half a turn.</p>	 <p>3 Loosen one sealing plug or one pipe connection and open it by about one turn.</p>
 <p>4 Drain filter.</p>	 <p>5 Disassemble container.</p>	 <p>6 Remove used filter element from the container and dispose of in an environmentally friendly manner.</p>
 <p>7 Clean container.</p>	 <p>8 Complete container.</p>	 <p>9 Unpack new filter element and O-rings.</p>
 <p>10 Complete filter element.</p>	 <p>11 Insert the completed filter element into the container.</p>	 <p>12 Assemble container.</p>
 <p>13 Tighten the loosened plug or the loosened pipe connection with the specified torque.</p>	 <p>14 Evacuate the air from filter, then start machine or unblock supply pipe.</p>	

9.7 Clean container









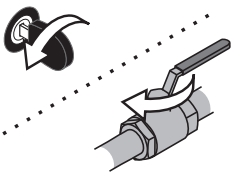

The container must always be cleaned each time the filter element is changed.

NOTICE

Do not use any alcohol-content cleaners!

Alcohol changes the material properties of the container!

1. Use clean diesel oil exclusively for the cleaning.
2. Do not use any hard or sharp-edged objects.
3. Remove contamination completely with a soft cloth.

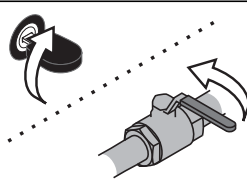
 <p>1 Stop machine or block supply pipe.</p>	 <p>2 Drain filter.</p>	 <p>3 Disassemble container.</p>
 <p>4 Remove used filter element from the container and dispose of in an environmentally friendly manner.</p>	 <p>5 Clean container.</p>	 <p>6 Complete container.</p>
 <p>7 Unpack new filter element and O-rings.</p>	 <p>8 Complete filter element.</p>	 <p>9 Insert new filter element.</p>
 <p>10 Assemble container.</p>	 <p>11 Start machine or unblock supply pipe.</p>	

10 Waste disposal

All component parts of the filter must be disposed of environmentally correctly, in accordance with the legal stipulations in the country where used.

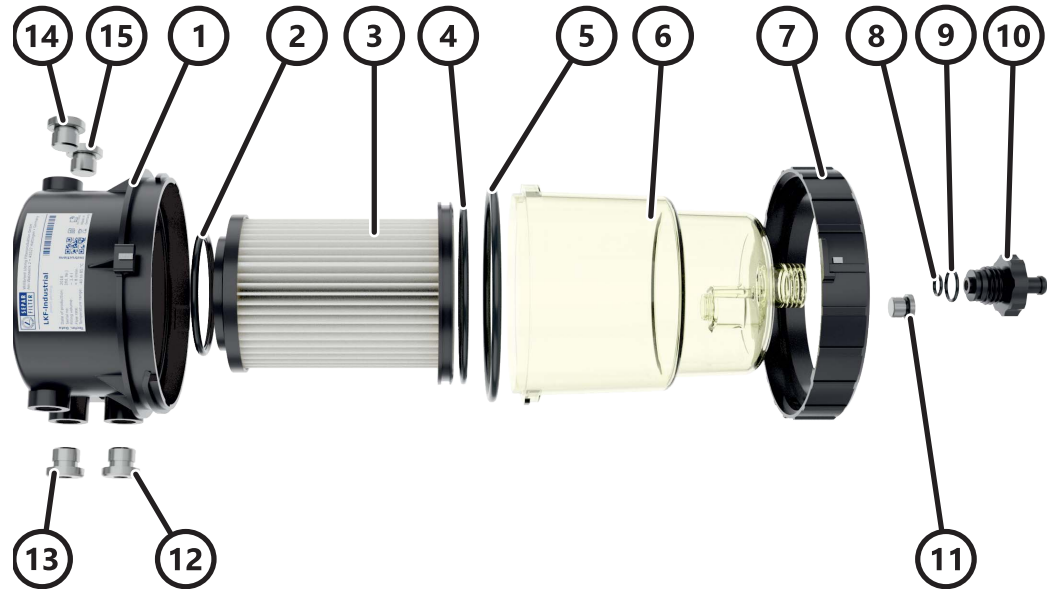

11 Spare parts

Tabelle 2: Spare parts

Position	Description	REF
1 ... 15	LKF-Industrial with filter element 10 µm	06 3832
	LKF-Industrial with filter element 3 µm	06 3834
	LKF-Industrial with filter element 6 µm	06 3835
2, 3, 4	LKF-Industrial, filter element 10 µm	06 3742
	LKF-Industrial, filter element 3 µm	06 3740
	LKF-Industrial, filter element 6 µm	06 3741
5, 6, 8, 9, 10	LKF-Industrial, container with drain valve	06 3836
5, 8, 9	LKF-Industrial, seal set, consisting of 2 × O-ring seal for drain valve 1 × O-ring seal for container	06 3837
7	LKF-Industrial, bayonet ring	06 3713
11	Sealing plug PG7 with O-ring seal	06 1558
12, 13, 14, 15	Sealing plug M16×1.5 with flat seal	06 3715

12 Accessories

Tabelle 3: Accessories

Illustration	Description	REF
	LKF wrench	06 3819
	Connector plug for WSA water sensor	06 1834
	WSA water sensor	06 1381
	Hand fuel pump HFP	06 3880





SEPAR Embodies Performance And Reliability

